

VACUUM VIEWPORTS

- Introduction 103
- CF Viewports109

Neyco manufactures a range of UHV viewports in CF, ISO or KF flange styles including a variety of coatings to enhance performance.

Materials include:

- Kodial (borosilicate glass)
- Fused Silica
- Quartz natural
- Sapphire
- Barium Fluoride BaF_2
- Calcium Fluoride CaF_2
- Magnesium Fluoride MgF_2
- Zinc Selenide ZnSe
- Zinc Sulfide Cleartran

Viewports are manufactured in cleanroom conditions and Helium leak tested, cleaned and packed to UHV standards.

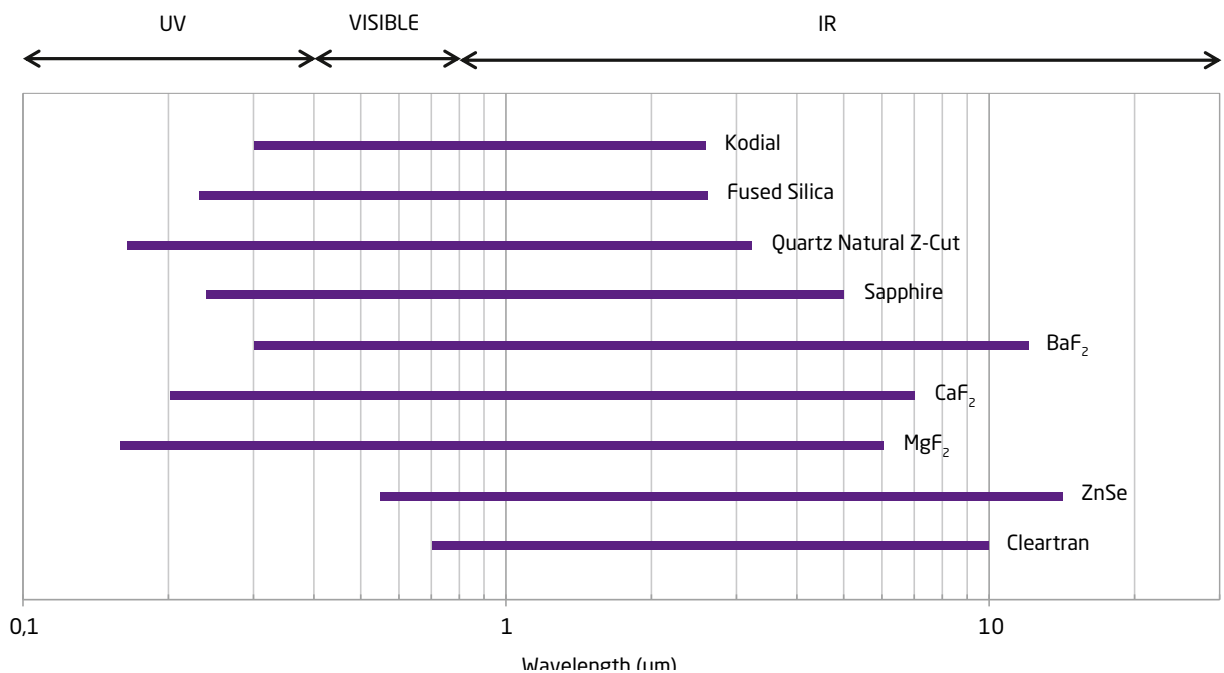

Comparison of some viewports materials transmission spectra

Introduction

VIEWPORTS MATERIALS

KODIAL

The viewports comprise a Borosilicate glass optic which is sealed to a Kovar weld ring using an induction heater process.

The optic assemblies are TIG welded to flanges. The rugged construction of the Kodial viewports allows repeated bakeout with UHV performance.

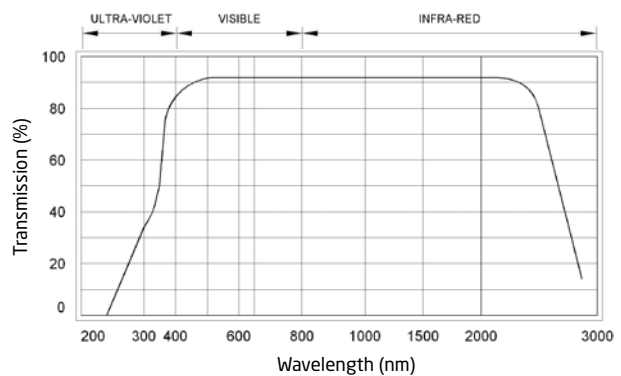

QUARTZ FUSED SILICA

The viewports comprise a high purity laser quality fused silica optic with precise flatness, parallelism, scratch and dig specifications.

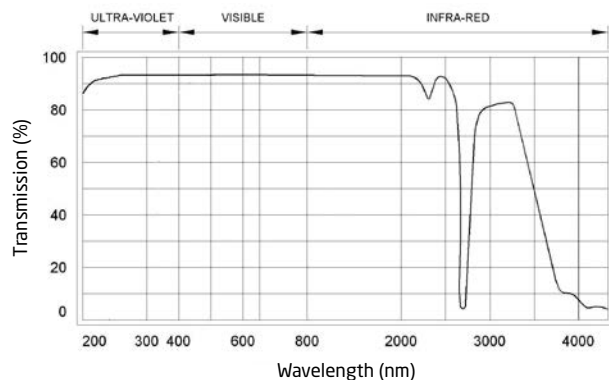

QUARTZ NATURAL Z-CUT

The viewports comprise a high quality natural quartz optic with precise flatness, parallelism, scratch and dig specifications.

One of the best materials for transmission of wavelengths above 50 μm is z-cut crystal quartz, so z-cut quartz windows are popular as THz* windows. It is important that z-cut

crystal quartz windows are also transparent in the visible spectrum allowing easy adjustment with a HeNe laser and do not change the state of light polarization. Z-cut quartz also has excellent transparency in the vacuum UV portion of the spectrum and is therefore a popular window material for use in UV spectroscopy and UV lithography.

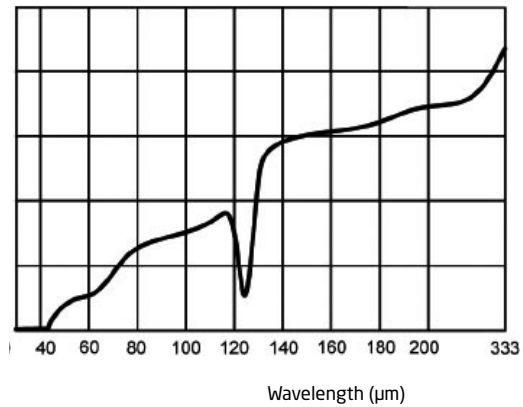
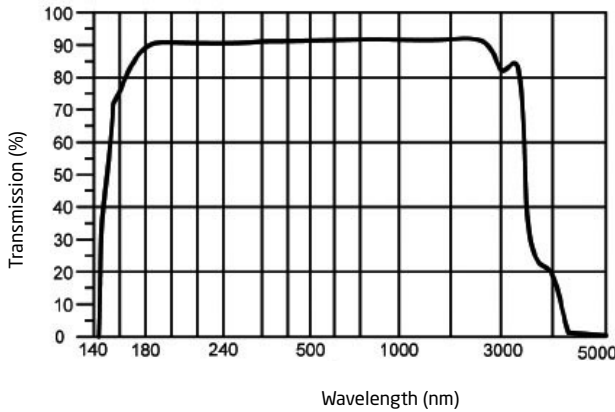

*THz: Terahertz radiation is located in the spectral region ~ 3 mm - 30 μm (~ 0.1-10 THz)

SAPPHIRE

The viewports comprise a high quality optic with precise flatness, parallelism, scratch and dig specifications.

The single crystal sapphire windows have excellent optical, physical and chemical properties. The hardest of the oxide crystals, sapphire retains its high strength at high temperatures. Sapphire has a low coefficient of thermal expansion and low fluorescence, good resistance to thermal shock and scratching making this an excellent material for IR transmitting optics and robust applications. C-cut sapphire is selected to minimise the effects of birefringence.

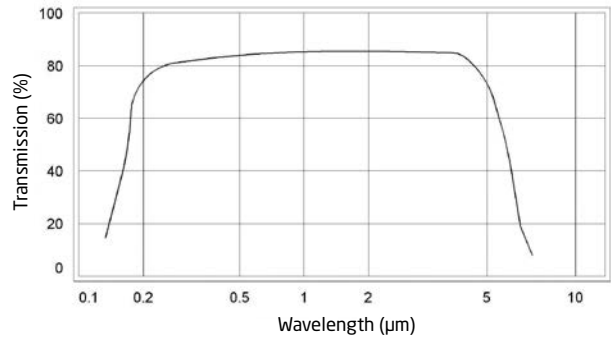

BARIUM FLUORIDE BaF₂

Barium Fluoride is used for windows, lenses and prisms, particularly when transmission into the ultraviolet is desired. Barium Fluoride is suitable for applications in the IR band (8 to 12 μm) and is often used as a IR viewport window for thermography.

Barium Fluoride is less resistant to attack by water than Calcium Fluoride. Barium Fluoride is the most resistant fluoride to high energy radiation but does not have VUV transmission of other types. The material is relatively hard but is very sensitive to thermal shock.

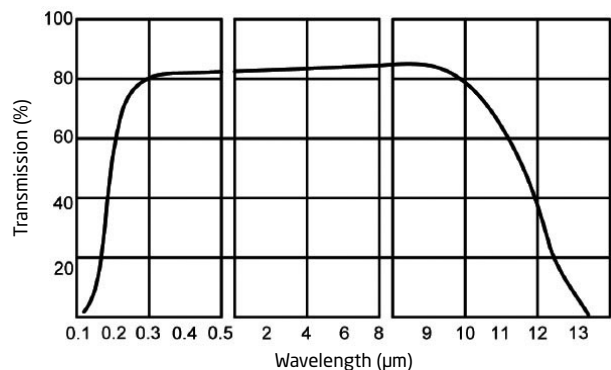

CALCIUM FLUORIDE CaF₂

Best transmission by Fluoride crystals in the UV (except very weak LiF). Mechanically only slightly weaker than Zinc Selenide and slightly harder. Single crystal material with cubic symmetry, hence no birefringence. Calcium Fluoride is transparent in the visible (appears similar in color to quartz or glass) and in the UV down to 120 nm, which services all excimer laser applications. Low index of refraction, which means that the windows rarely require antireflective coatings.

The rugged, bonded construction of the CaF₂ viewports allows bake-out to a maximum of 120°C with UHV performance.

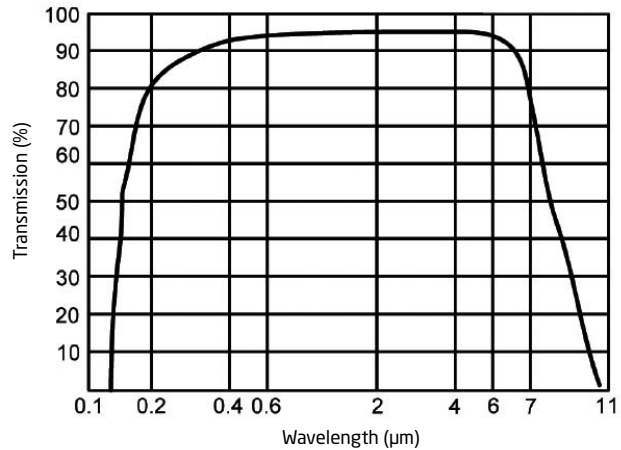

MAGNESIUM FLUORIDE MgF₂

Next best transmission of fluorides compared to CaF₂ and similar in all other characteristics with the following exceptions. MgF₂ is stronger and harder and is naturally, strongly birefringent

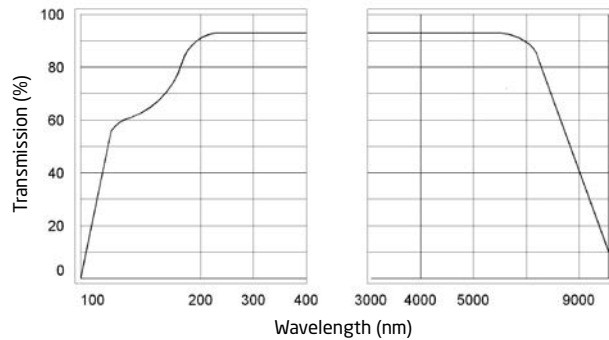

ZINC SELENIDE ZnSe

The viewports comprise a laser quality Zinc Selenide optic with precise flatness, parallelism, scratch and dig specifications.

Best transmission available at 10.6 μm (CO₂ laser fundamental line) and in the visible. It has some absorption in the blue-green causing it to appear yellow. The index of refraction is high and thus requires anti-reflection coatings on both sides for optimum performance. This polycrystalline, CVD grown material is strong, though relatively soft compared to other crystalline, optical materials. It is non-hygroscopic. ZnSe sublimates at 300°C and reacts violently with strong mineral acids.

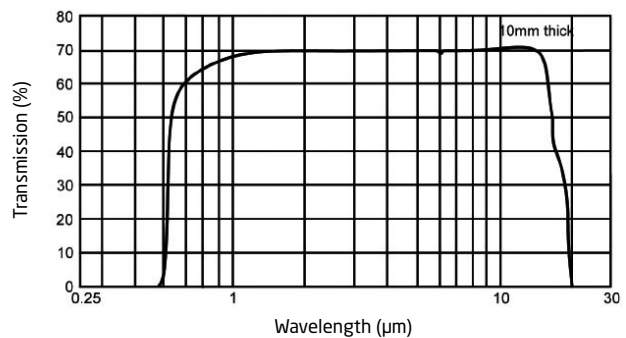

ZINC SULFIDE CLEARTRAN

Comparable to ZnSe in most respects, only slightly more absorbing at 10.6 μm. Advantage is the transmission in the visible is better, no absorption to only slight absorption in the bluegreen thus appearing clear (i.e. not yellow). It is much harder than ZnSe and thus resists scratching much better.

Cleartran is a form of CVD Zinc Sulfide that is modified by a post-deposition hot isostatic process. This process removes Zinc hydrides from the crystal lattice, normalizes crystal structure and purifies the material, all contributing to single crystal-like transmittance in the visible through far infrared ranges (0.35-14 μm).

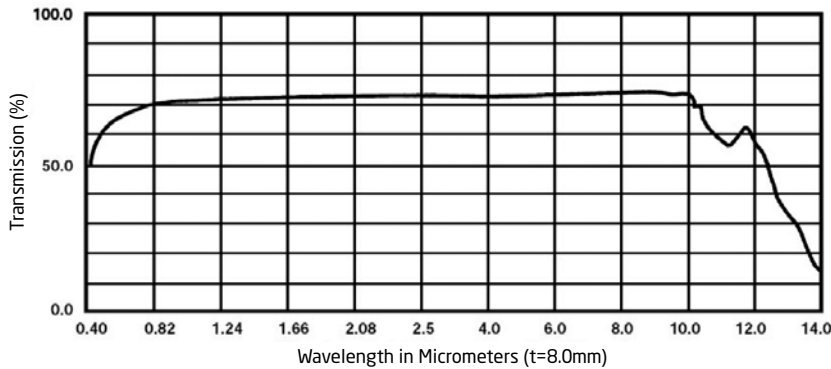

Please note that the optical transmission curves are approximations and should be used for reference only.

FLANGE AND WELD RING MATERIALS

The UHV CF versions are offered using high grade Stainless Steel 304L or 316LN flanges.

Flanges in Stainless Steel 316L are used for the high vacuum KF and ISO viewports.

FLANGE TYPE	GLASS TYPE	WELD RING MATERIAL	
		MAGNETIC	NON MAGNETIC
CF 304L KF 316L ISO 316L	Kodial Quartz Sapphire ZnSe	Kovar	-
	CaF ₂ BaF ₂ MgF ₂	316L	-
CF 316LN	Kodial Quartz Sapphire ZnSe	Kovar	Tantalum
	CaF ₂ BaF ₂ MgF ₂	-	316L

TECHNICAL SPECIFICATIONS

	KODIAL	FUSED SILICA	SAPPHIRE	QUARTZ NATURAL Z-CUT	ZnSe	BaF ₂	CaF ₂	MgF ₂
Seal type	Braze Bond Mechanically sealed	Braze Mechanically sealed		Braze Bond Mechanically sealed	Bond Mechanically sealed			
Maximum temperature	120°C ⁽¹⁾ 130°C ⁽²⁾ 150°C (KF & ISO) ⁽³⁾ 350°C (CF) ⁽³⁾	150°C (KF & ISO) 200°C (CF)	150°C (KF & ISO) 200°C (CF)	120°C ⁽²⁾ 150°C (KF & ISO) ⁽³⁾ 200°C (CF) ⁽³⁾	120°C ⁽²⁾ 130°C ⁽¹⁾			
Minimum temperature	-20°C							
Maximum rate of temperature change	3°C / min							
Leak rate	< 1.10 ⁻¹⁰ mbar.l.sec ⁻¹ (He)							
Pressure range	1 bar to 1.10 ⁻¹¹ mbar ⁽⁴⁾							
Surface quality (scratch / dig)	20/10	20/10	60/40	20/10	60/40			
Parallelism	-	< 3 arc minutes			-	-	-	-
Flatness	λ/4 ⁽¹⁾⁽²⁾ , < 8λ ⁽³⁾	< 8λ	< 8λ	λ/4 ⁽²⁾ , < 8λ ⁽³⁾	< 2λ	λ/4		

(1) For mechanically sealed viewport

(2) For bonded viewport

(3) For brazed viewport

(4) 1.10⁻⁸ mbar for mechanically sealed viewport

ANTI-REFLECTIVE COATINGS

A range of anti-reflective coatings can be processed and optimised to customer specified wavelengths. Theoretical reflectance curves can be supplied on request for particular window material and wavelength combinations. The coatings are processed on eBeam system in cleanroom conditions and tested on a state of the art UV-Vis spectrophotometer.

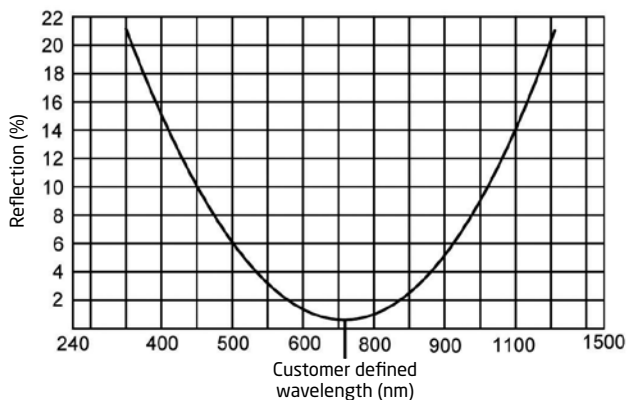

Reflectance curve with BBAR anti-reflective coating

Viewports are offered with :

- a **single QWOT*** MgF₂ layer anti-reflective (AR) coating on both sides of the window optimised to a customer specified wavelength range (standard wavelengths between 190 nm and 1550 nm).
- a **two-layer VAR** or a **four-layer broadband BBAR** anti-reflective coating on both sides of the window optimised to a customer specified wavelength. In many cases, the coating reduces reflection to below 0.5% per face or 1% total at the wavelength specified (standard wavelengths between 240 nm and 1550 nm).

Coatings for other wavelengths can be quoted also on request.

*QWOT = Quarterwave optical thickness

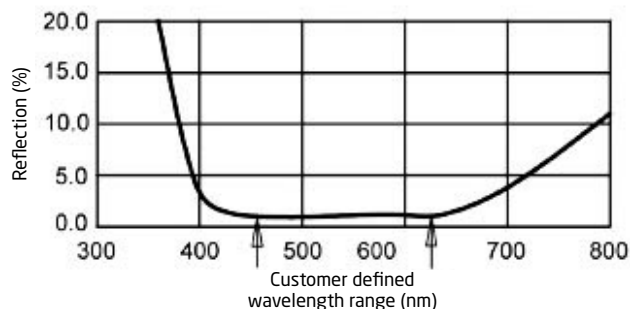

Reflectance curve with VAR anti-reflective coating

The graph below shows typical before and after transmission effect of AR, VAR, and BBAR anti-reflective coatings on Kodial viewports.

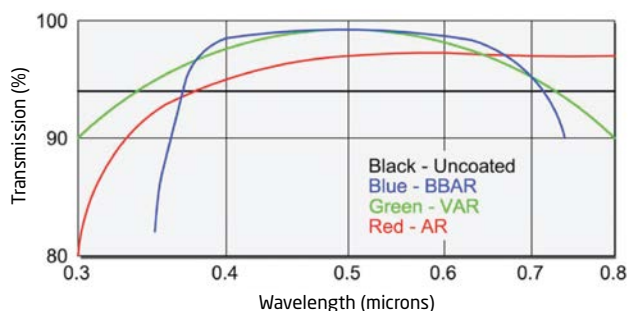

Please note that the optical transmission curves are approximations and should be used for reference only.

THIN FILM COATINGS

Neyco also coats viewports with transparent conductive coatings such as ITO (Indium Tin Oxide) on the vacuum side of the window to provide surface conductivity either to eliminate electrostatic charge build up or to improve EMC/RFI screening.

CF Viewports

TUBULATED VIEWPORTS

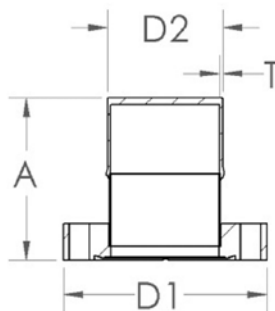
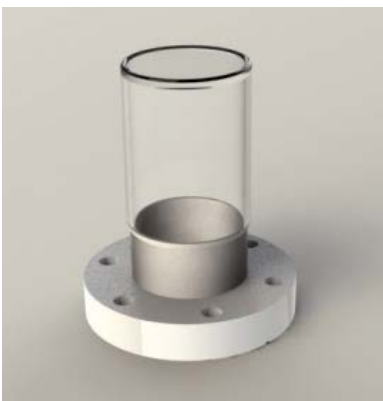

DIMENSIONS FOR CF FLANGES

P/N		DN	A	D1	D2	T
KODIAL	FUSED SILICA					
VP13	VP13Q	16	30	34	13	1.0
VP19	VP16Q	35	30	70	19	1.5
VP63	-	63	70	114	64	2.0

Note: Dimensions subject to raw material supplier tolerances.

These viewports are also available with KF and ISO flanges on request.

All dimensions are in mm.

CF ZERO LENGTH VIEWPORTS

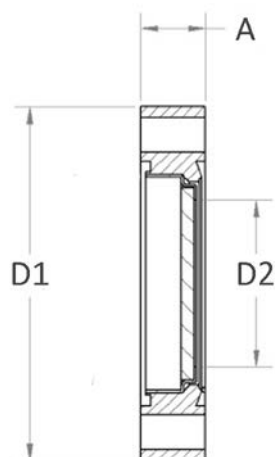

P/N KODIAL	DN	A	D1	D2
VPZ16	16	12.7	34	16
VPZ38	40	12.7	70	33
VPZ38LA	40	12.7	70	39
VPZ64	63	17.4	114	63
VPZ100	100	19.9	152	89
VPZ150	160	22.3	203	136
VPZ200	200	24.5	254	136

P/N		DN	A	D1	D2	C QUARTZ / QUARTZ NAT.	C SAPPHIRE	C BaF ₂	C CaF ₂	C MgF ₂	C ZnSe
FUSED SILICA	SAPPHIRE										
VPZ16Q	VPZ16S	16	12.7	34	15	1.5	1.5	2	1.5	2.5	1.5
VPZ38Q	VPZ38S	40	12.7	70	32	3	1.5	4	3	3	3
VPZ38LAQ	VPZ38LAS	40	12.7	70	38	3.5	1.5	5	3.5	4	3.75
VPZ64Q	VPZ64S	63	17.4	114	63	4.5	2	7	5	5	5
VP100Q	VP100S	100	19.9	152	89	6	2.5	9	7	6.5	6.5
VPZ150Q	VPZ150S	160	22.3	203	136	9.5	4	-	-	9.5	9.5
VPZ200Q	VPZ200S	200	24.5	254	136	9.5	4	-	-	9.5	9.5

P/N	QUARTZ NATURAL Z-CUT	BaF ₂	CaF ₂	MgF ₂	ZnSe
DN from 16 to 200	BVPZ--NQZ	BVPZ--BAF2	BVPZ--CAF2	BVPZ--MGF2	BVPZ--ZNSE

All dimensions are in mm.

CF ZERO LENGTH VIEWPORT WITH X-RAY PROTECTION LEAD GLASS

CF Kodial viewports are offered including an additional 5 mm thick Lead glass disc clipped into the atmosphere side of the Kodial window for X-Ray protection. The viewports comprise a borosilicate glass optic which is sealed to a Kovar weld ring using an induction heater process. The Kodial/Lead glass window assembly provides visible transmission.

LEAD GLASS SPECIFICATIONS

OPTICAL PROPERTIES	
Refractive index	1.76
Transmission % @ 550 nm trough 5mm path	≥ 85.0
CHEMICAL PROPERTIES	
Lead (Pb)	48%
Barium (Ba)	15%
MECHANICAL PROPERTIES	
Density (g/cm ³)	4.8
Knoop hardness (kg/mm ²)	440
Young's modulus (GPa)	62.7
Poisson's ratio	0.23

SHIELDING CHARACTERISTICS

THICKNESS	MINIMUM LEAD EQUIVALENCE (mm) FOR STATED X-RAY TUBE VOLTAGE					
	100 kV	110 kV	150 kV	200 kV	250 kV	300 kV
mm						
5 - 6.5	1.7	1.6	1.5	1.3	1.3	1.3

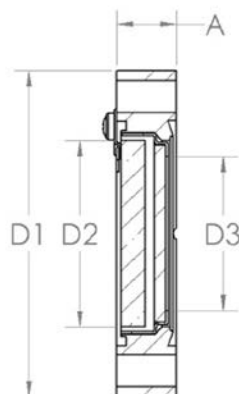

P/N	P/N REPLACEMENT LEAD GLASS	DN	A	D1	D2	D3
VPZ16LG	LG16	16	12.7	34	18	16
VPZ38LG	LG38	40	12.7	70	42	33
VPZ64LG	LG64	63	17.4	114	72	63
VPZ100LG	LG100	100	19.9	152	106	89
VPZ150LG	LG150	160	22.3	203	156	136

All dimensions are in mm.

DEMOUNTABLE VIEWPORTS

Demountable high transmission viewports offer the option to apply optical coatings or cleaning of the viewports. For higher temperature applications up to 250°C, Kalrez O-rings can be used.

All of the demountable viewports employ a recessed zero profile glass design, which provides the widest viewing angles and maximum protection from damage.

Many types of materials (quartz, sapphire...) are available for glass replacement. Coated glasses on specification are also available on request.

- Standard glass material: Kodial
- Vacuum range: 1.10^{-8} mbar

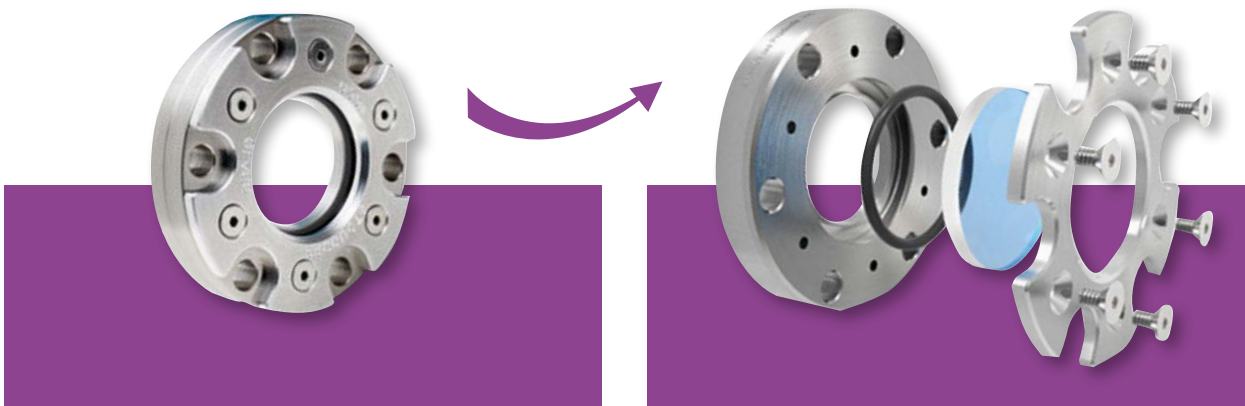

P/N	DN	FLANGE OD	VIEW DIAMETER	GLASS THICKNESS
DKVPZ16	16 KF	30	14.22	4
DKVPZ40	40 KF	54.9	30.22	4
DVPZ16	16 CF	33.8	14.22	4
DVPZ40	40 CF	70.1	30.22	4

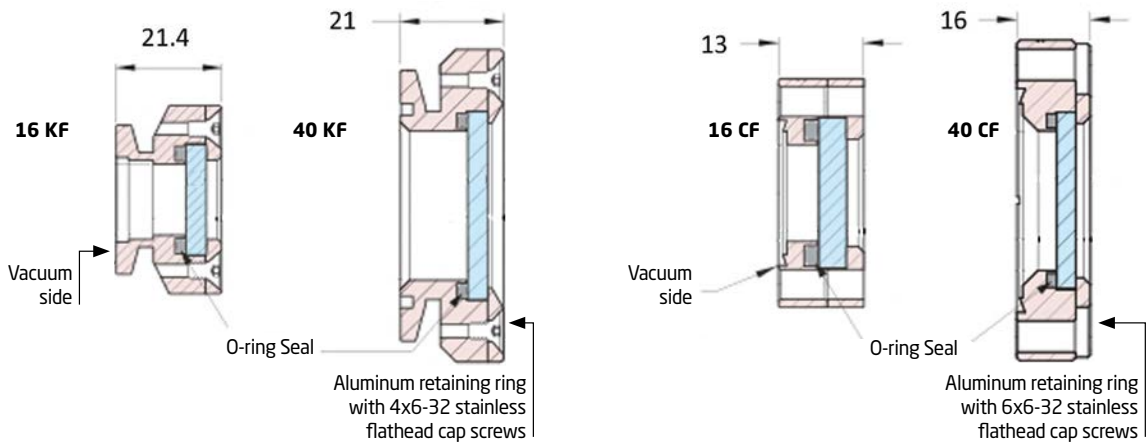

All dimensions are in mm.

KODIAL RE-ENTRANT CF VIEWPORTS

Re-entrant viewports are typically used to insert microscopes or cameras in UHV/Vacuum systems. The re-entrant viewports are offered in CF flanges as standard, but custom designed viewports can be manufactured using ISO and KF flange styles on request.

The viewports comprise a borosilicate glass optic which is sealed to a Kovar weld ring using an induction heater process.

Anti-reflective coatings to match customer reflectance requirements are also processed.

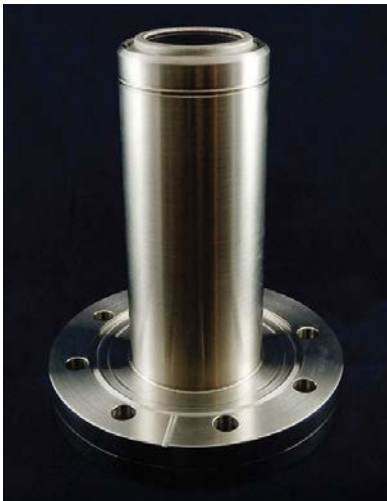

P/N	DN	A	B	C	D	E
VPZ40R	40	70	15	22.5	20.2	111
VPZ63R	63	114	32	50.8	47.5	138
VPZ63LAR	63	114	38	57.2	53.2	80
VPZ100R	100	152	63	76.2	70.2	201
VPZ160R	160	203	63	108	102	330
VPZ200R	200	254	89	159	153	330

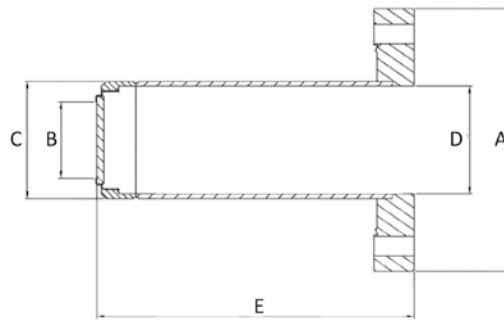

All dimensions are in mm.



neyco

30 avenue de la Paix
92170 VANVES - France
Tel: +33(0)1 41 90 50 50
Fax: +33(0)1 41 90 50 51

www.neyco.fr



Vacuum | 2013-2

neyco